



**/ Milan 42 / 60**

**Extra priechnik znamená extra komfort**

# / VŠEOBECNE

Tento masívny oporný stojan v tvare U s oblými rohmi je ideálny na skladovanie a upevnenie dvoch bicyklov. Vďaka priečniku je vhodná aj na parkovanie detských a dámskych bicyklov.



# / ÚDAJOVÝ LIST

## Štruktúra

- Ohýbaná oceľová rúra (Dxd = 42x3 mm alebo 60x3 mm)
- 2 kotviace platničky (Dxd = 150x5 mm alebo 200x5 mm)
- Predĺženie na zabetónovanie

## Materiál

- Oceľ

## Verzia

- D = 42 mm
- D = 60 mm
- Na kotviacich platničkách
- Zabetónovanie

## Možnosti pripojenia

- Áno

## Povrchová úprava

- Žiarovo pozinkovaná oceľ
- Žiarovo pozinkovaná oceľ a prášková farba

## Rozmery

### Kotviace platničky

- DxŠxV = 1000x42x800mm (Dxd = 150x5mm)
- DxŠxV = 1000x42x800mm (Dxd = 200x5mm)
- DxŠxV = 1200x42x900mm (Dxd = 150x5mm)
- DxŠxV = 1000x60x800mm (Dxd = 150x5mm)
- DxŠxV = 1000x60x800mm (Dxd = 200x8mm)

### Zabetónovanie

- DxŠxV = 800x42x (800 + 270) mm
- DxŠxV = 1000x42x (800 + 270) mm
- DxŠxV = 1000x60x (800 + 300) mm

### Ukotvenie

- Zabetónovanie
- Kotviace platničky
  - Priamo na chodníku pomocou klinových skrutiek
  - S skrutkami a hmoždinkami na 2 betónových blokoch 30x30x40cm
  - Chemickým ukotvením

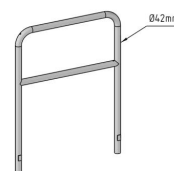
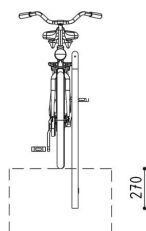
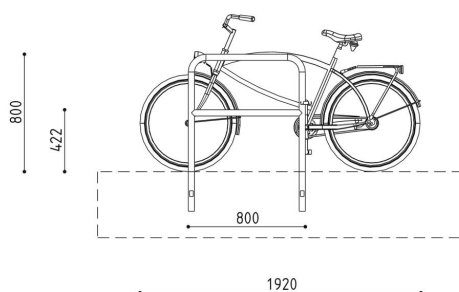
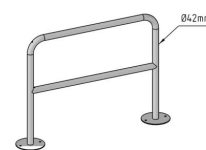
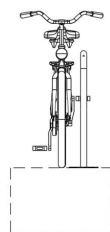
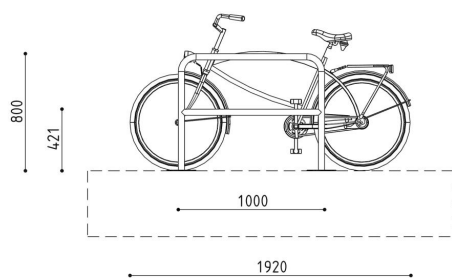

# / INŠPIRÁCIA



# / TECHNICKÉ INFORMÁCIE 1

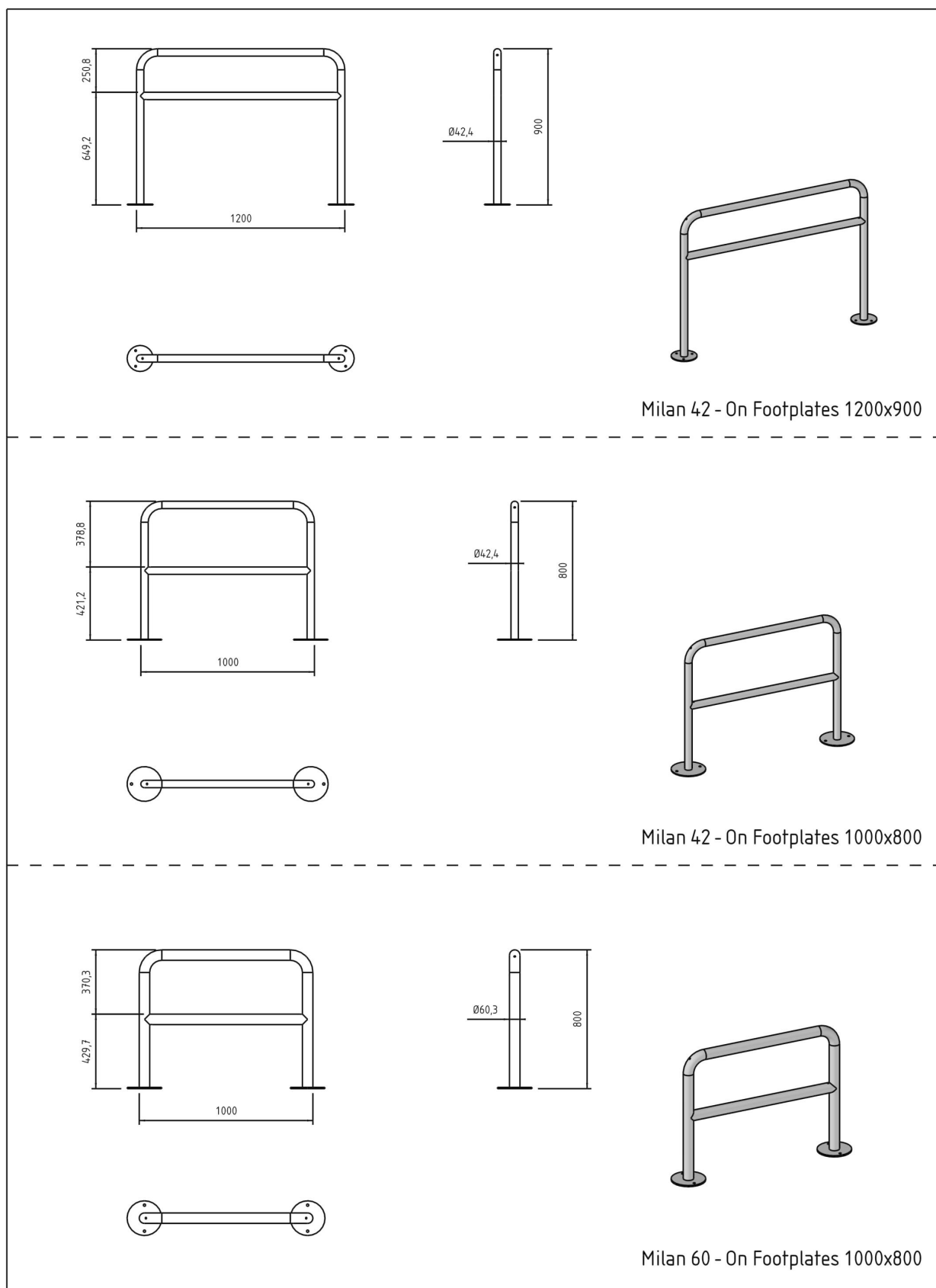

# / TECHNICKÉ INFORMÁCIE 2

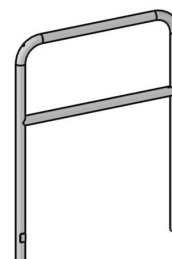
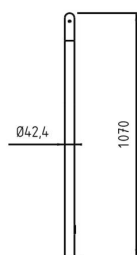
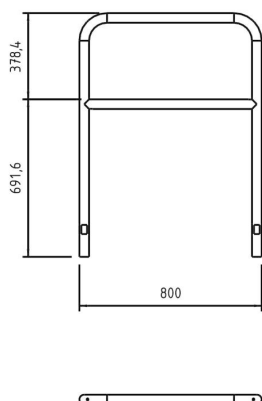

Milan 42 - In concrete 800x1070

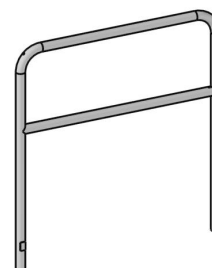
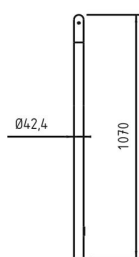
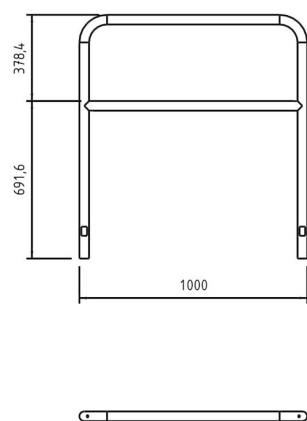

Milan 42 - In concrete 1000x1070

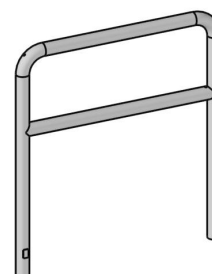
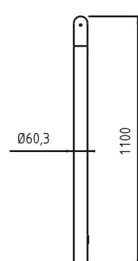
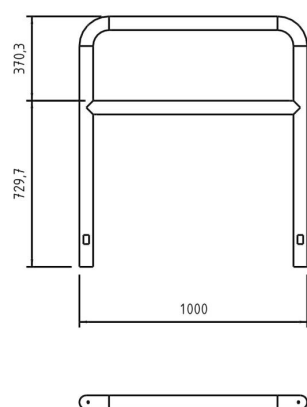

Milan 60 - In concrete 1000x1100